

Advanced CV-Measurements and Calibration at the Wafer-Level

Quick How-To Reference

C-V Instrumentations

Agilent 4980A



Agilent 4294A



Keysight E4990A



Keithley 4200-SCS



Keysight B1500A



C-V Instrumentations: Auto-Balancing Bridge Method

Agilent 4980A

- Keithley 4200+CVU : 1 kHz to 10 MHz | DC Bias : Up to 30V

Agilent 4294A

- Agilent B1500+MFCMU : 1 kHz to 5MHz | DC Bias : Up to 25V

Keysight E4990A

- Agilent 4980A : 20 Hz to 2 MHz | DC Bias : Up to 40V

- Agilent 4294A : 40 Hz to 110MHz | DC Bias : Up to 40V

- Agilent 4981A : 120 Hz to 1 MHz | DC Bias : None

Keithley 4200-SCS

- Keysight E4990A : 20Hz to 120MHz | DC Bias : Up to 40V - NEW

Keysight B1500A

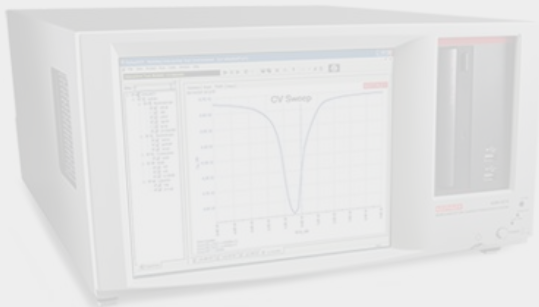

Auto-Balancing Bridge Method (ABB)

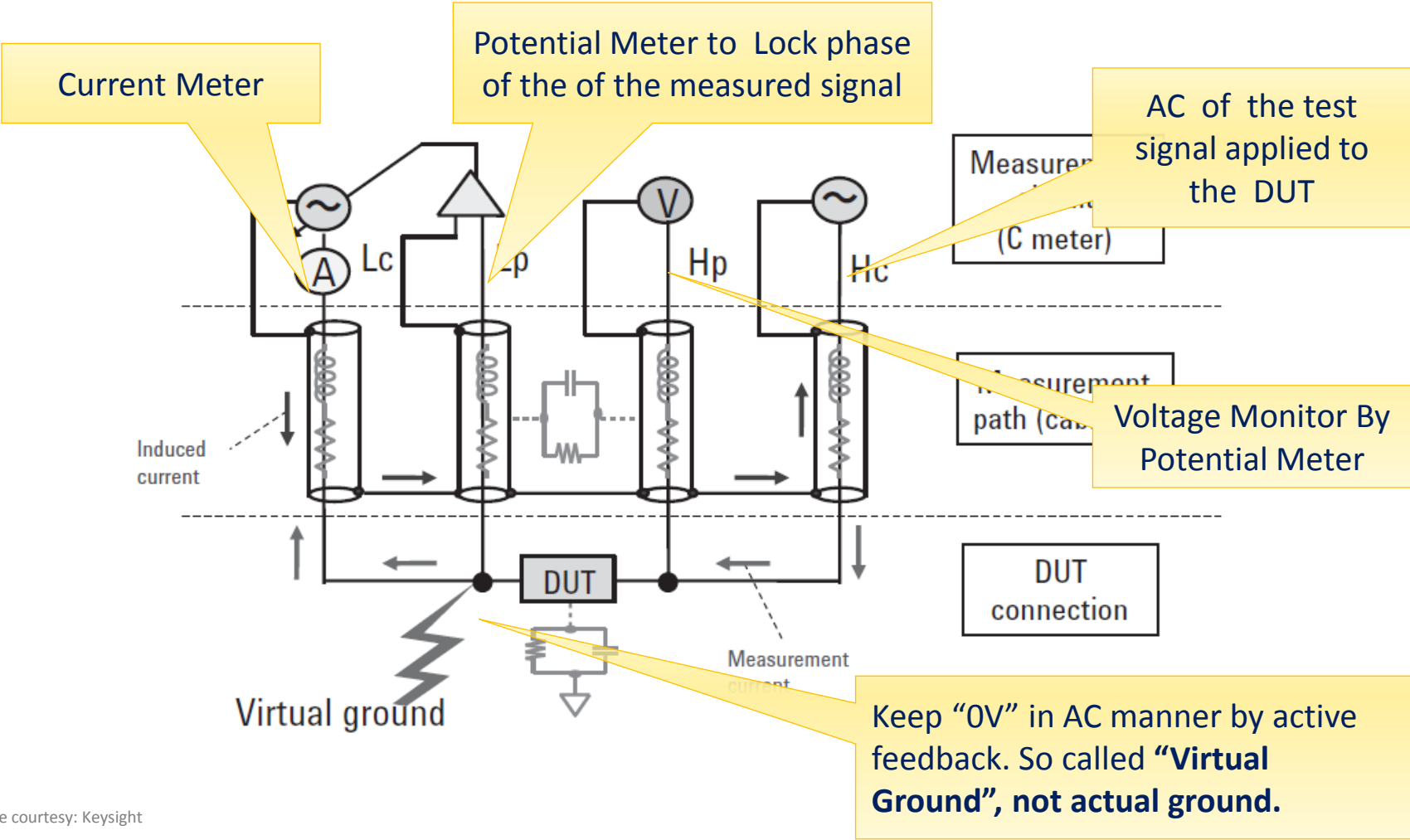

Picture courtesy: Keysight

ABB: Sources of Errors

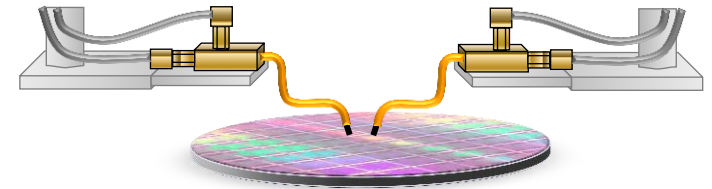
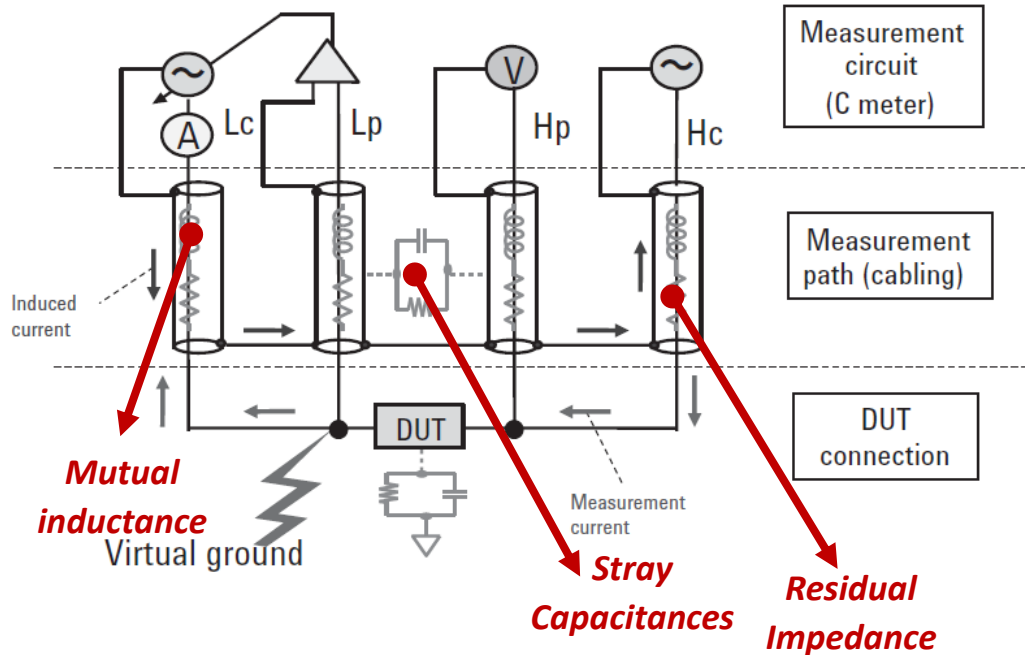

- Residual impedance in the cables
- Stray capacitance between cables or to ground
- Mutual inductance caused by the current flow between adjacent cables

ABB: Sources of Errors

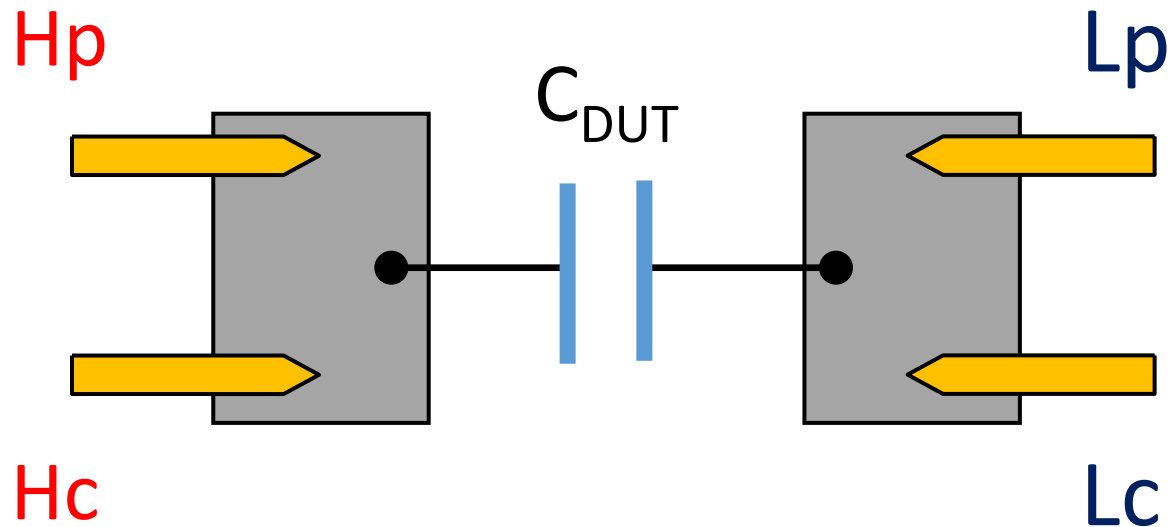

Eliminate cable resistance from the measurements

MPI Solutions: Kelvin Probe Arm

- Eliminate the effects of the residual impedance
- Shielding the cables to eliminate stray capacitance
- Vertical self-leveling for easy tip replacement
- 2M | 1M Direct Impedance Analyzer BNC to SSMB to Probe with no disturbance
- Easy to reconnect for different IV/CV/PIV measurements
- For Ultra Low noise and accurate IV/CV Measurement in open and Shield Environment System

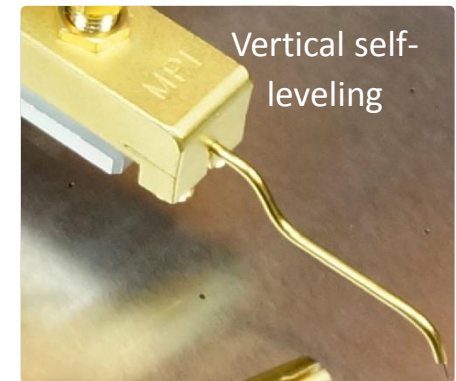
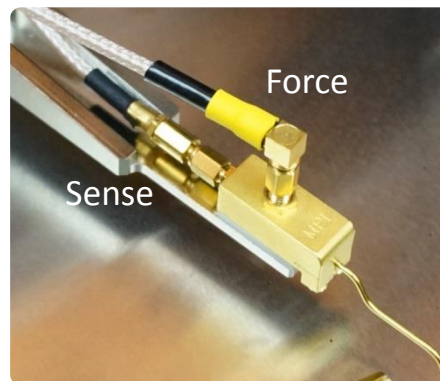
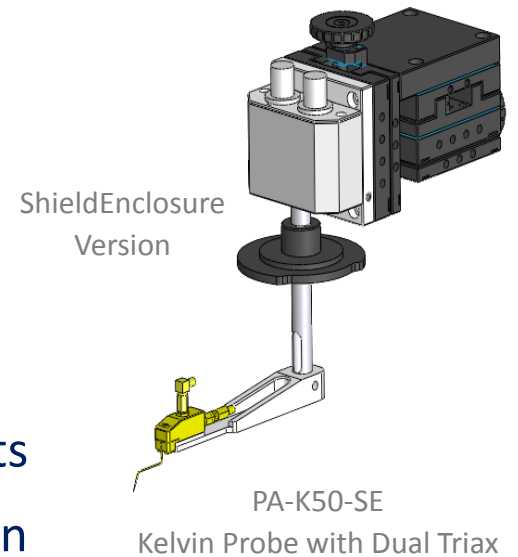

MPI Solutions: V-Ground Connector

- Provide 4-TP Connection for accurate CV at higher frequency $>2\text{MHz}$
- Eliminate the mutual inductance between cables
- Provides the shortest connection for virtual ground
- Included in the Kelvin Probe

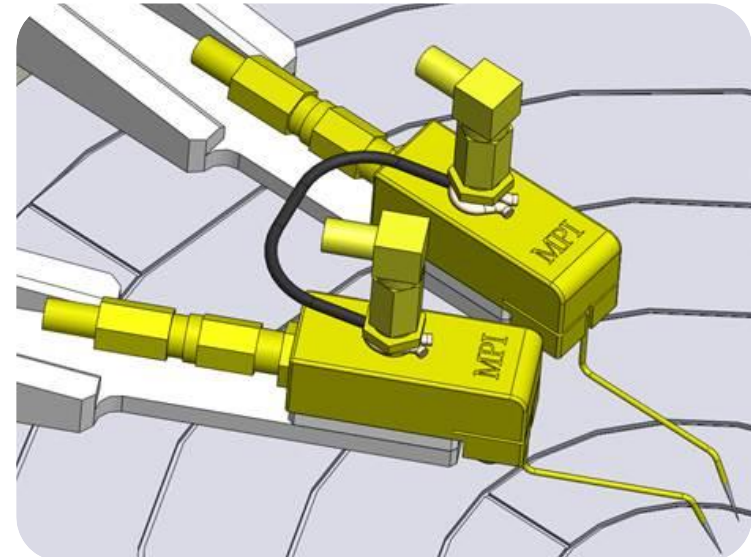
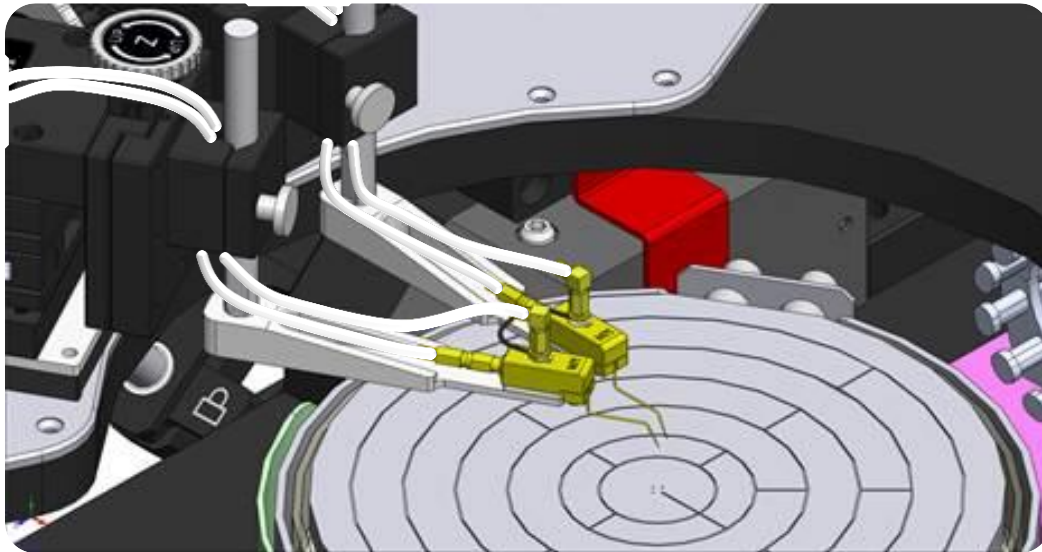
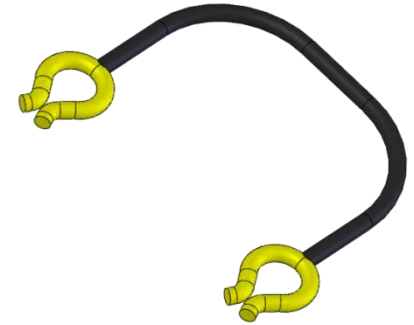

On wafer verification on Calibration Substrate

- System needs to be calibrated with Open/Short or Open/Short/Load calibration method from the CV instruments prior to any measurement
- MPI calibration substrates include required standards and are qualified using the NIST methodology
 - loads are accurately trimmed to 50 Ohm with $< 0.3\%$ error
 - reference capacitance for CV calibration verification
- Recommended substrate models:
 - AC-3 for DUT pads $< 50 \mu\text{m} \times 50 \mu\text{m}$
 - AC-5 for lager pads

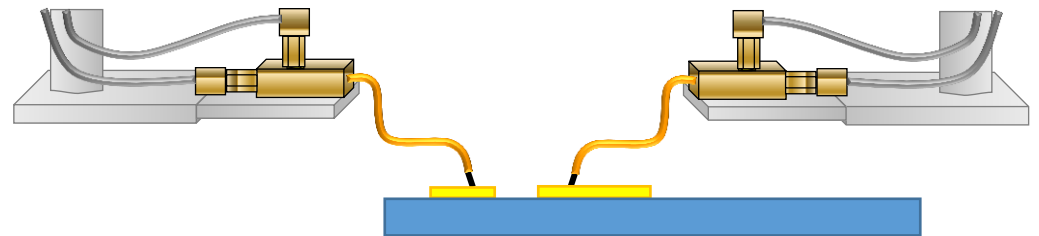

Calibration Substrates Qualified: AC-2 Example

Nominal capacitance per unit length, pF/cm	1.492
Nominal characteristic impedance @20 GHz	50 Ω
Effective dielectric constant @20 GHz, real part	4.94
Effective velocity factor @20 GHz	0.45
Parameters of the simplified model of line losses	
Reference loss, dB	0.34
Reference delay, ps	25.5
Reference frequency, GHz	20

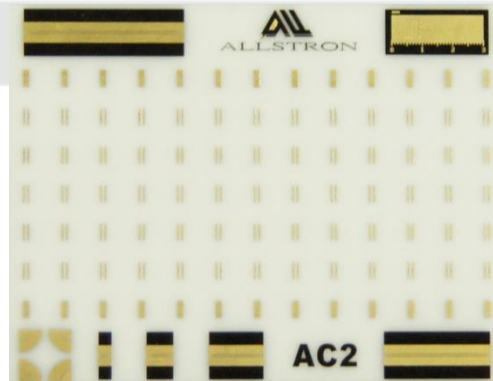

Calibration Substrates Qualified: NIST methodology

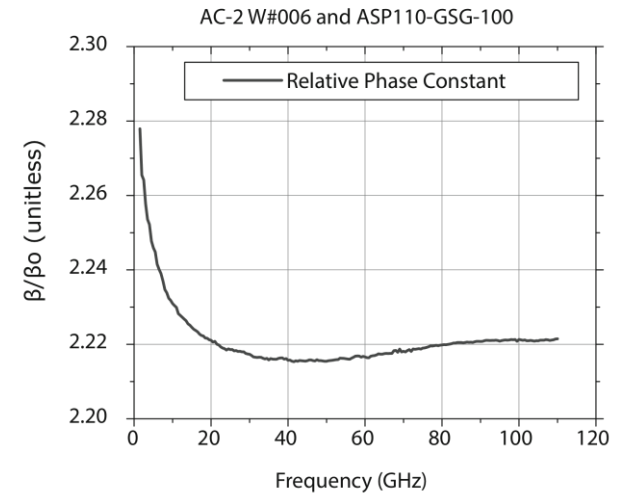
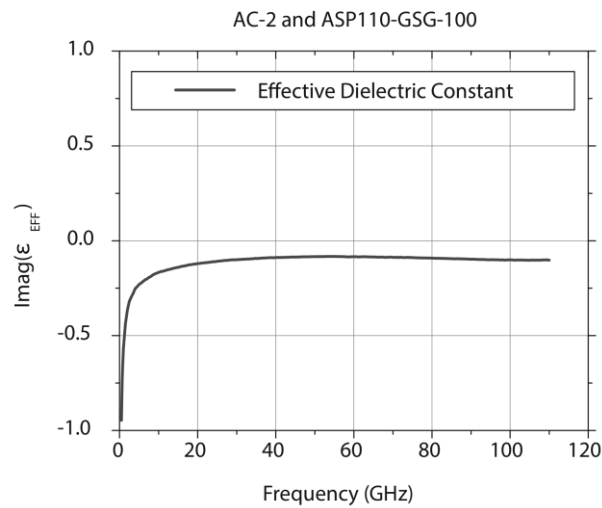
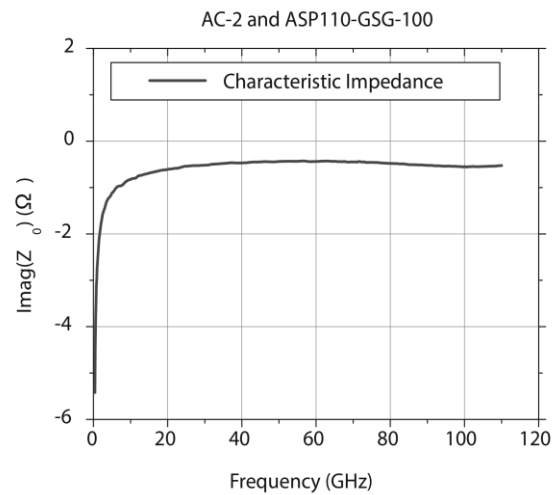
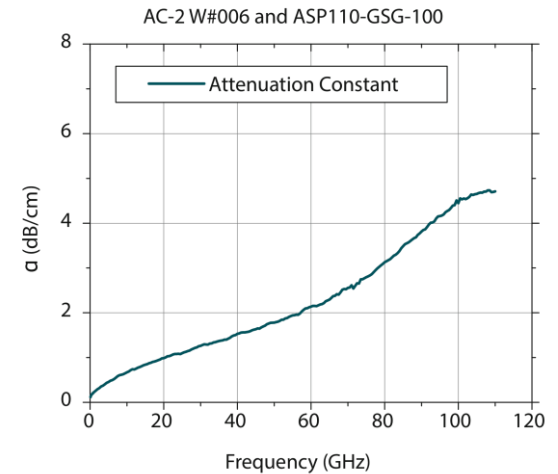
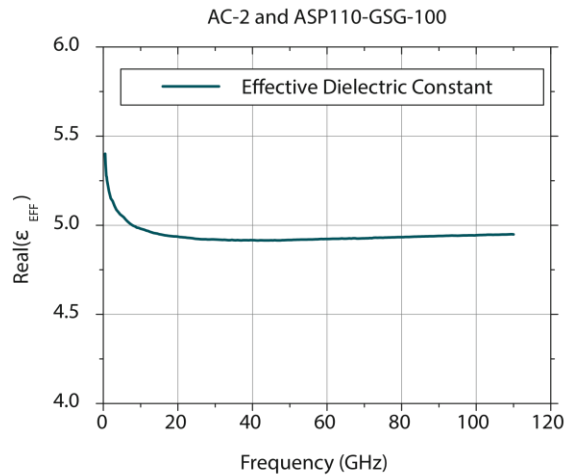
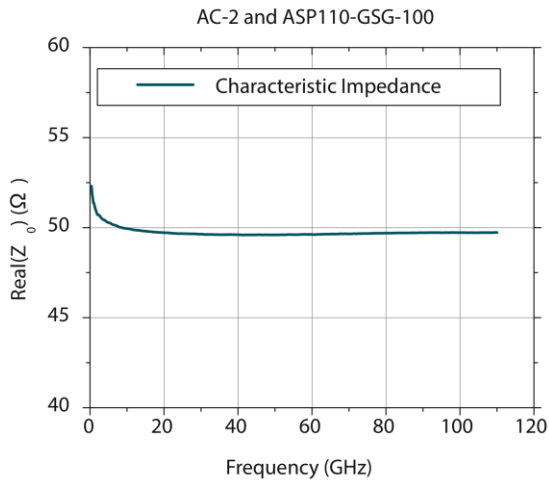

AC-3: Open Standards

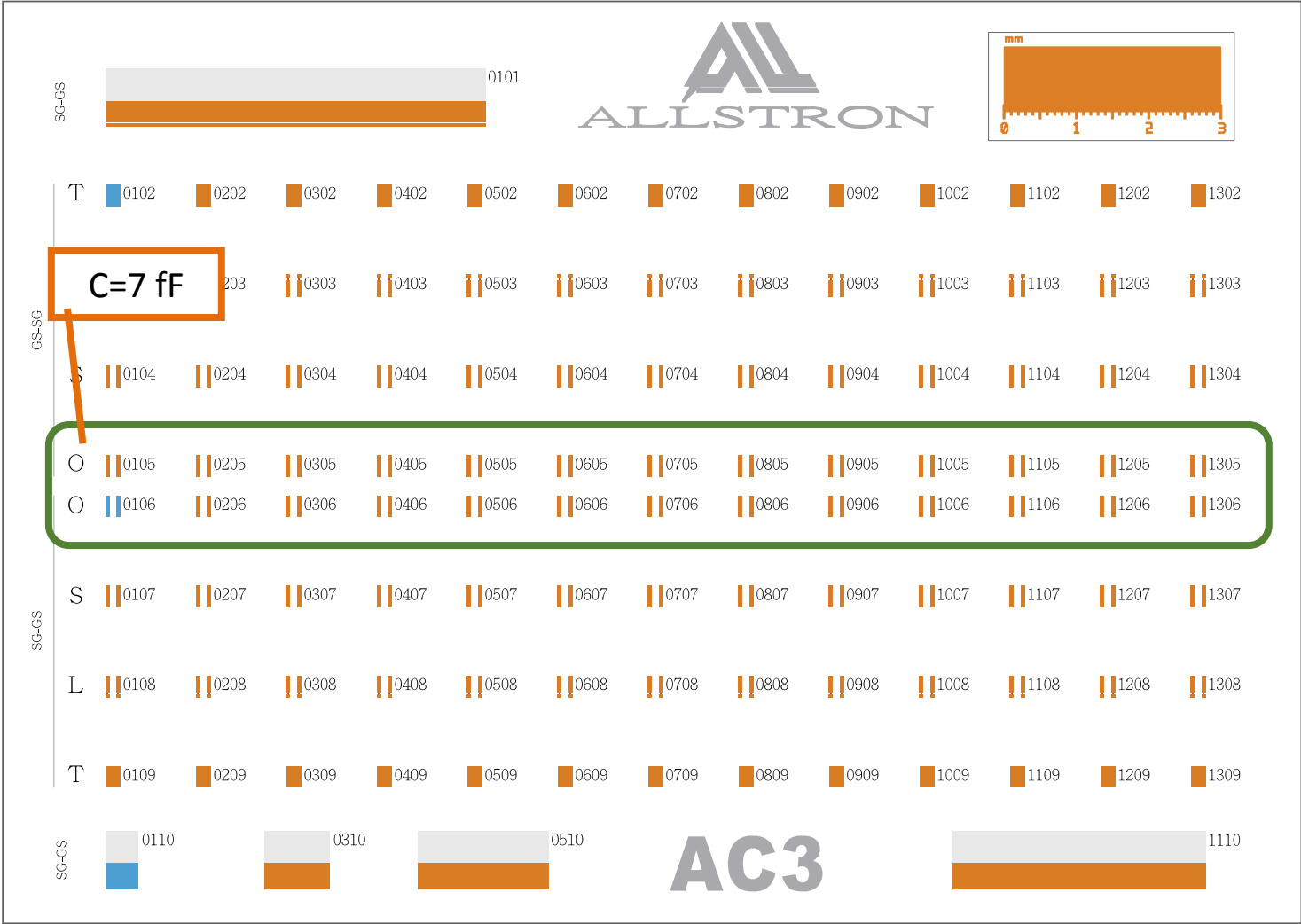

AC-3: Open Standards (Optional)

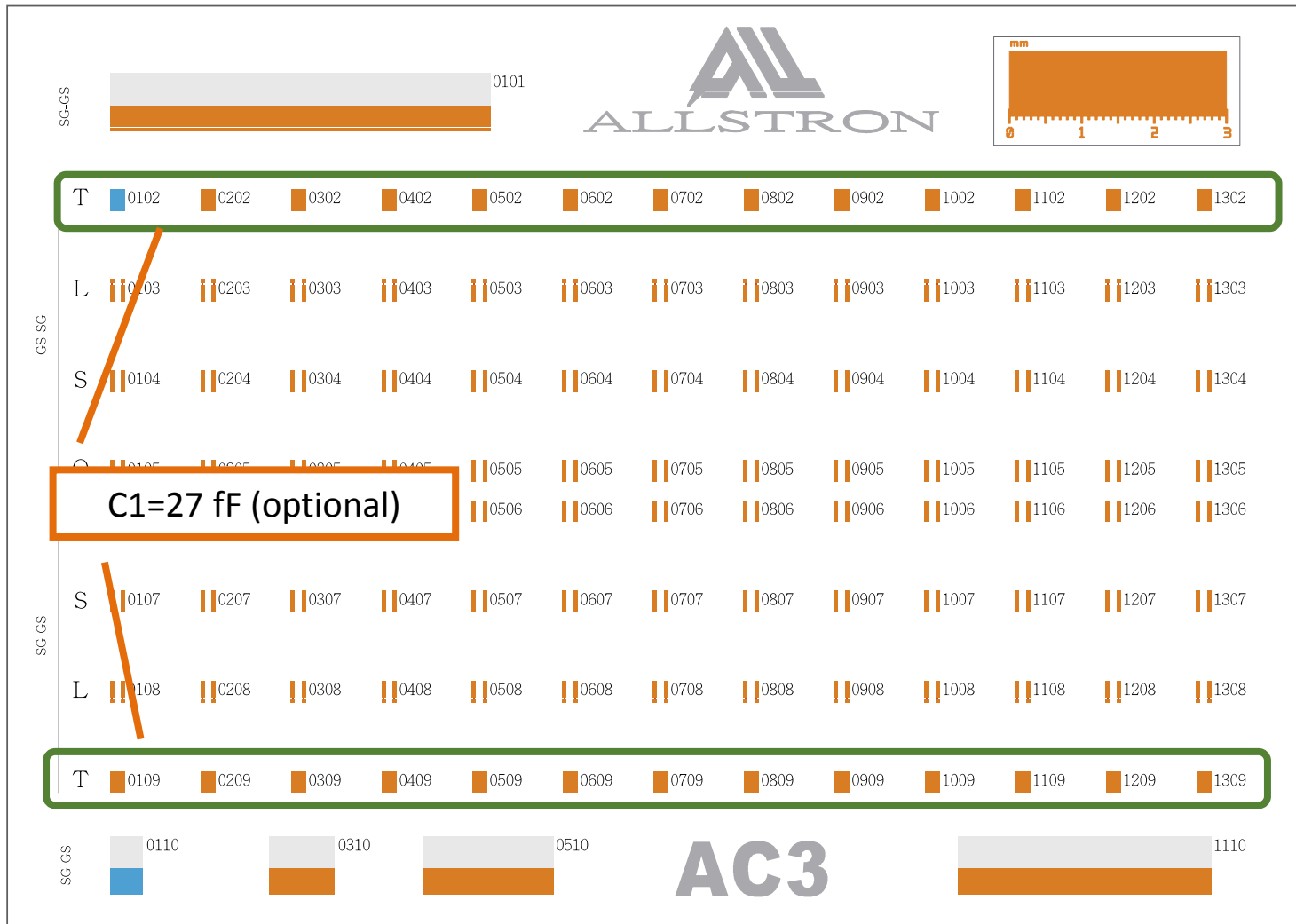

AC-3: Short Standards



AC-3: Calibration Loads

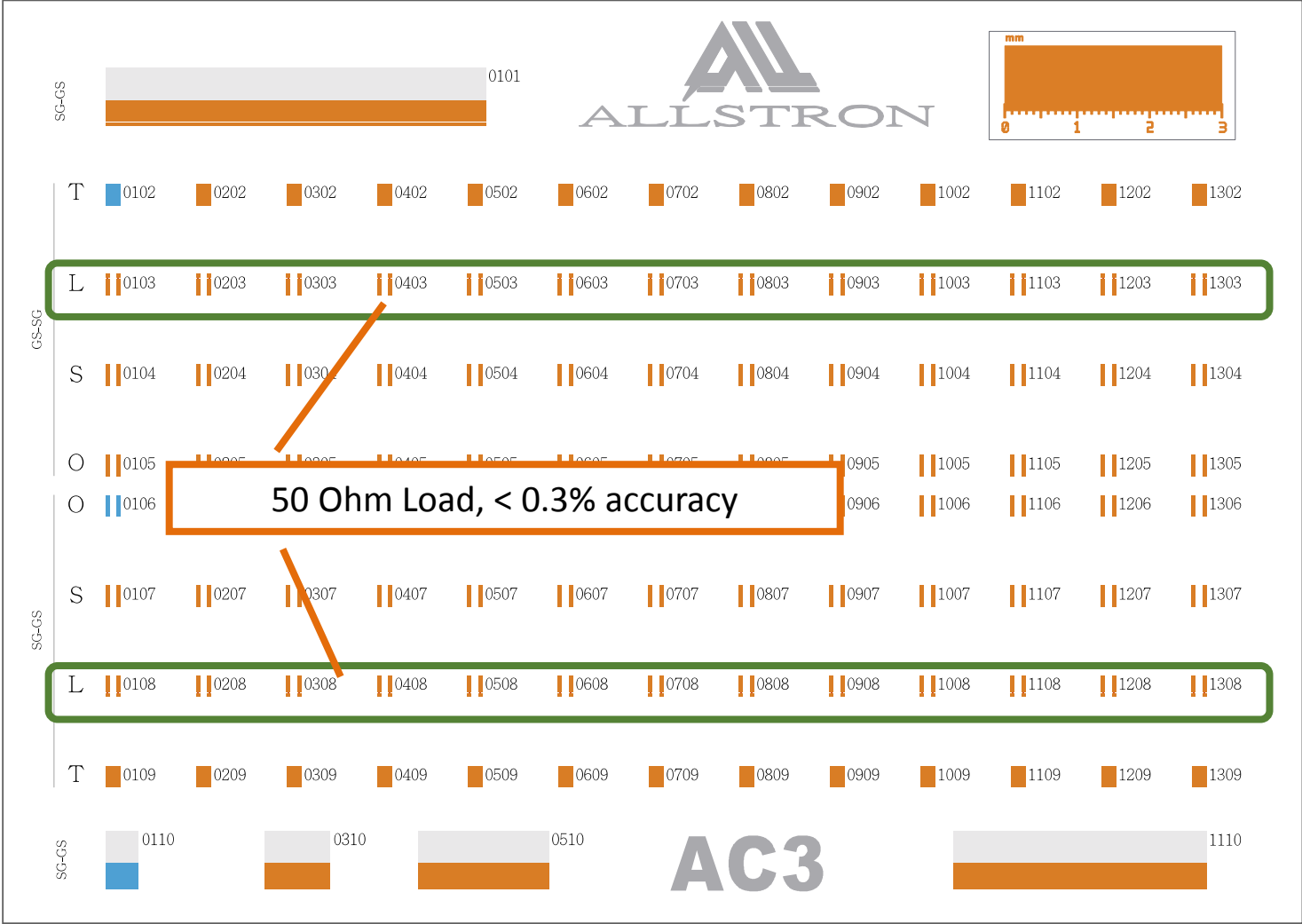

AC-3: Verification Capacitances

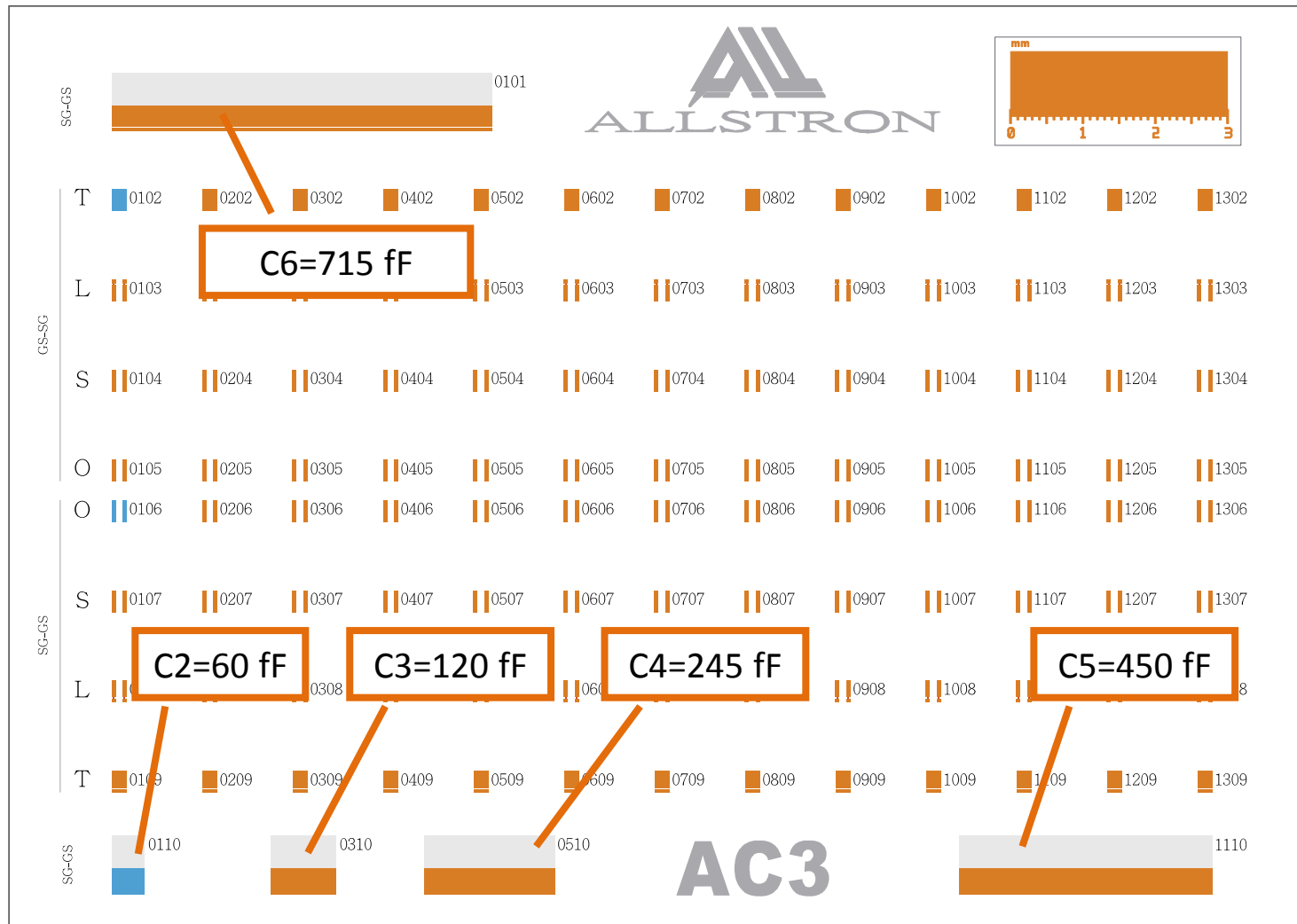

**THANK YOU
FOR YOUR ATTENTION**

 **MPI** CORPORATION

For more information, please visit:
www.mpi-corporation.com