

2601B-PULSE System SourceMeter® 10 μ s Pulser/SMU Instrument

Datasheet



The new 2601B-PULSE System SourceMeter 10 μ s Pulser/SMU Instrument with PulseMeter™ technology is an industry-leading high current/high speed pulser with measure plus the full functionality of a traditional SMU. This new pulser offers leading 10 A current pulse output at 10 V with a pulse width minimum of 10 μ s, perfect for testing vertical cavity surface emitting lasers (VCSEL) used in LIDAR and facial recognition, LEDs for lighting and displays, semiconductor device characterization, surge protection testing, and so much more. The pulser's built-in dual 1 Megasample/second (MS/s), 18-bit digitizers make it possible to acquire both pulse current and voltage waveforms simultaneously without the need to use a separate instrument. The 2601B-PULSE is a powerful solution that significantly boosts productivity in applications ranging from benchtop characterization

through highly automated pulsed I-V production test. For automated system applications, the 2601B-PULSE's Test Script Processor (TSP®) runs complete test programs from inside the instrument for industry-best throughput. In larger, multi-channel applications, the Keithley TSP-Link® technology works together with TSP technology to enable high-speed, pulser/SMU-per-pin parallel testing. Because the 2601B-PULSE offers full isolation that does not require a mainframe, it can be easily reconfigured and re-deployed as your test applications evolve.

Key Features

- Industry leading 10 A @ 10 V, 10 microsecond pulse output
- No tuning required; works with inductive loads up to 3 μ H
- Dual 1 Megasample/second digitizers for high speed I/V pulse measurements (pulser function only)
- DC capability up to ± 40 V @ ± 1.0 A, 40 Watt
- TSP technology embeds complete test programs inside the instrument for best-in-class system-level throughput
- TSP-Link expansion technology for multi-channel parallel test without a mainframe
- USB 2.0, LXI Core, GPIB, RS-232, and digital I/O interfaces
- Supported in the Keithley KickStart non-programming software tool

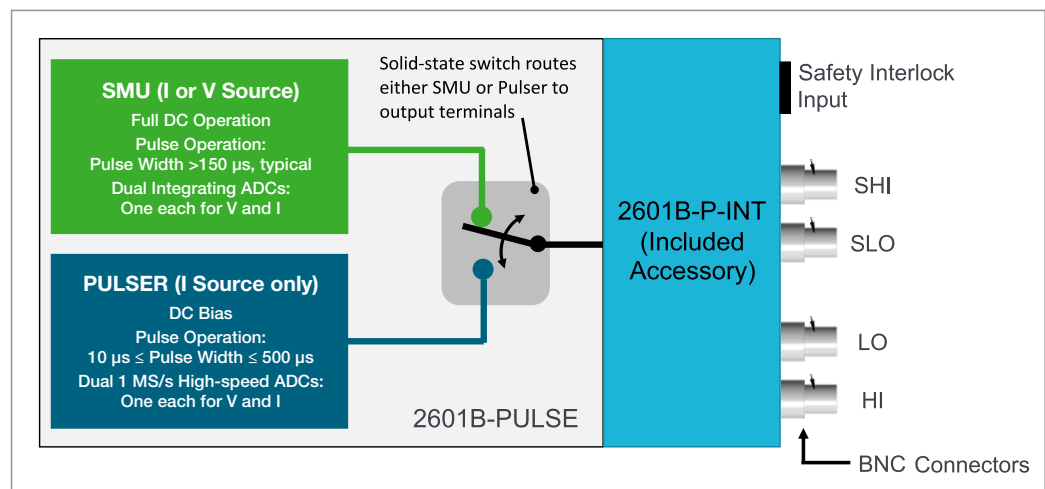

External Interlock/Connector box included with 2601B-PULSE

Pulsed Testing for Device Characterization

Testing real device operation and minimizing the heating effects with on-wafer testing just got easier with the 2601B-PULSE SMU. Thermal management is critical during the testing of many devices, especially those at the semiconductor wafer level, such as VCSELs, laser diodes, and LEDs. Pulsed I-V testing minimizes the heating effects of the current in the device, especially if tested at the wafer level when devices have no temperature control circuitry. Testing with DC would either change their characteristics, or at worst, destroy them. Later on, in production, when they have been assembled into modules with temperature controls, the devices can be DC tested and the results compared to those from the pulsed test. Some devices will pass a DC test and fail a pulsed test due to device characteristic changes resulting from temperature shift. The 10 V / 10 A / 10 μ s output of the 2601B-PULSE ensures that you get a proper output pulse into your device and an accurate measurement when it is required.

No Tuning Required

When outputting current pulses, cabling and inductance can be a problem. Inductance can have a limiting effect and could even be damaging. Quite often, the inductance can be different from device to device, even when testing laser diodes on a wafer. The effect of inductance on a current source is that inductance resists changes in current. This can cause the current source to increase the output voltage. The result is overshoot and ringing as the pulse settles. This may not be acceptable in your test. Some solutions require tuning to compensate for these behaviors, which can be time consuming. The 2601B-PULSE's control loop system eliminates the need to tune for load changes up to 3 μ H so that your pulse has no overshoot and ringing when outputting pulses from 10 μ s up to 500 μ s at a current up to 10 amps. This ensures a fast rise time, so your devices are sourced with a current pulse to properly characterize the device or circuit. The images on the next page show the performance of the 2601B-PULSE with PulseMeter technology compared to a competitive modular SMU outputting a 5 A, 50 μ s pulse on a device with an impedance of 3 μ H.

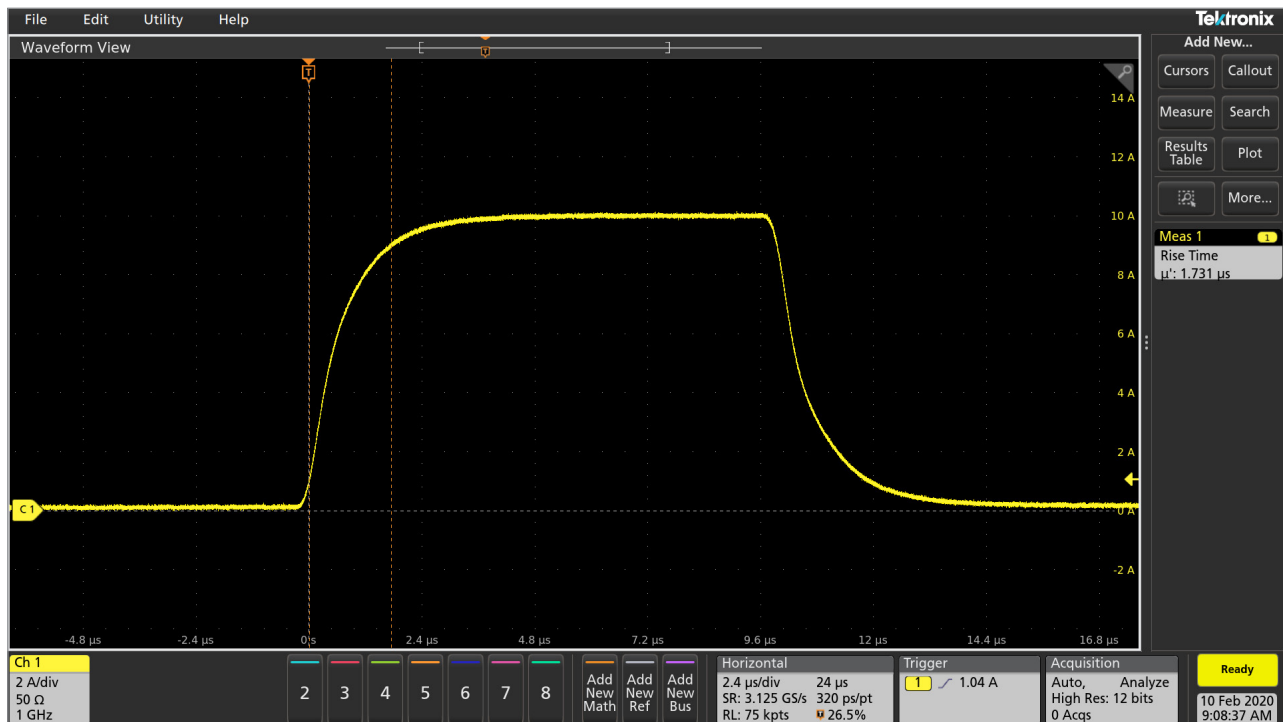

Pulse output performance of the 2610B-PULSE SMU.

Unmatched Throughput for Automated Test with TSP Technology

For test applications that demand the highest levels of automation and throughput, the 2601B-PULSE's TSP technology delivers industry-best performance. TSP technology goes far beyond traditional test command sequencers — it fully embeds, then executes, complete test programs from within the SMU instrument itself. This virtually eliminates the time-consuming bus communications to and from the PC controller, and thus dramatically improves overall test times.

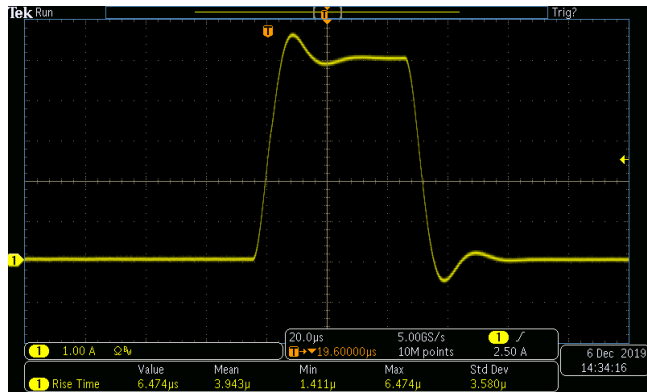

Typical pulse output from a competitive SMU with overshoot and 6.47 μ s rise time.

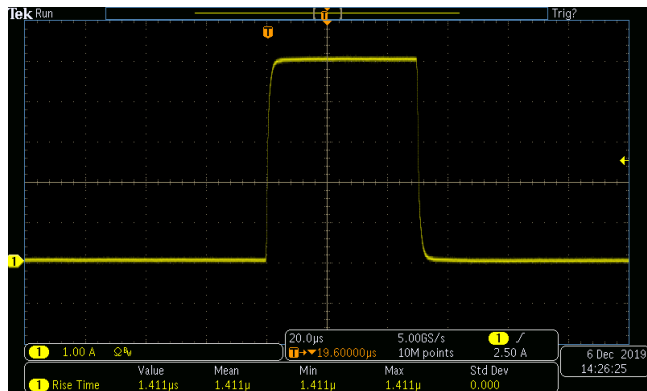

2601B-PULSE output without overshoot and 1.4 μ s rise time.

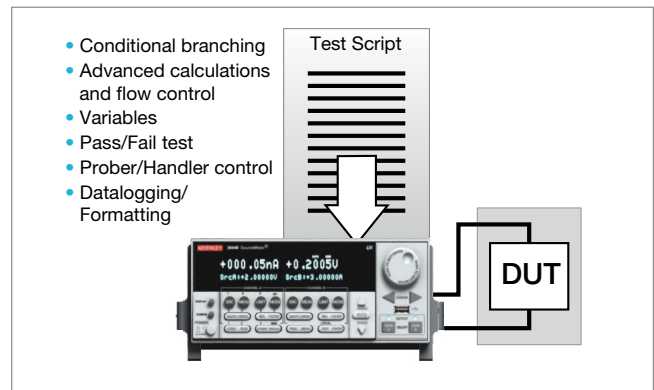

TSP technology executes complete test programs from the non-volatile memory of the 2601B-PULSE.

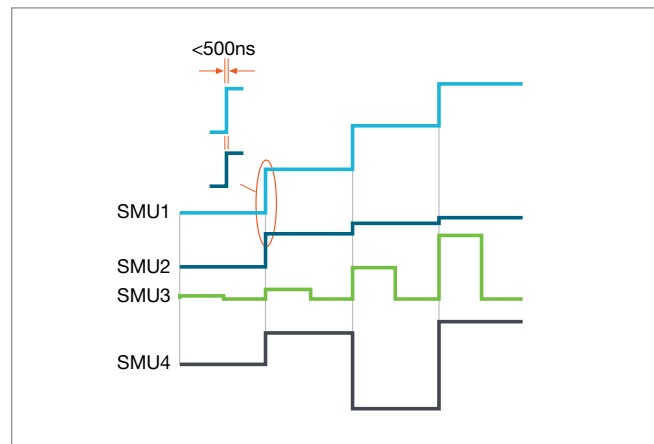

All channels in the TSP-Link system are synchronized to under 500 ns.

SMU-Per-Pin Parallel Testing with TSP-Link Technology

TSP-Link is a channel expansion bus that enables multiple 2601B-PULSE SMUs to be inter-connected and function as a single, tightly-synchronized, multi-channel system. The 2601B-PULSE's TSP-Link technology works together with its TSP technology to enable high-speed, SMU-per-pin parallel testing. Unlike other high-speed solutions, such as large ATE systems, the 2601B-PULSE achieves parallel test performance without the cost or burden of a mainframe. The TSP-Link based system also enables superior flexibility, allowing for quick and easy system re-configuration as test requirements change. TSP-Link uses a standard 100BASE-T ethernet cable, enabling you

to connect not only multiple 2601B-PULSE SMUs, but other TSP-based instruments in a master-subordinate configuration that operates as one integrated system. TSP-based instruments include the Keithley Graphical SourceMeter SMUs (2450, 2460, 2461, 2470), other Series 2600B System SourceMeter SMU instruments, the Keithley DMM7510 and DMM6500 Graphical Sampling Multimeters, and the Keithley DMM/Switch instruments, such as the Series 3700A Switch/Multimeter system and DAQ6510. The TSP-Link expansion bus supports up to 32 TSP-Link nodes, making it easy to scale a system to fit an application's particular requirements.

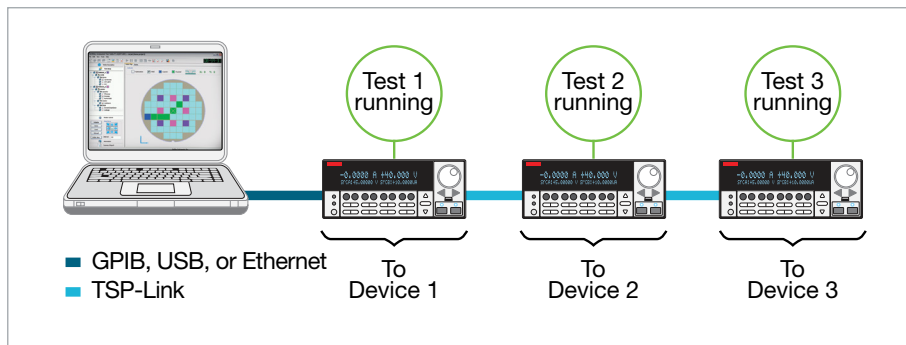

SMU-per-pin parallel testing using TSP and TSP-Link improves test throughput and lowers the cost of test.

Instrument Control Start-up Software

KickStart instrument control/start-up software enables users to start making measurements in minutes without programming. In most cases, users merely need to make some quick measurements, graph the data, and store the data to disk for later analysis in software environments such as Microsoft Excel. KickStart offers:

- Configure and control up to four SMU instruments for DC or Pulsed I-V test in either the same app, same project, or a combination of the two.
- Create tests by mixing any of these SMU instruments: 2400 Graphical Series, 2400 Standard Series (DC only), 2600B Series, 2651A, 2657A, and 6430 SourceMeter® SMU (DC only) instruments.
- Differentiate SMU instrument channels and their measurement data using labels that are relevant to your device or module.
- Native X-Y graphing, panning, and zooming; screenshot capturing of graphs.
- Spreadsheet/tabular viewing of data; export data for further analysis.
- Annotating of tests; save test setups.
- GPIB, USB 2.0, Ethernet compliance.



KickStart start-up software lets users be ready to take measurements in minutes.

Comprehensive Built-in Connectivity

Rear panel access to rear-input connectors, remote control interfaces (GPIB, USB 2.0, and LXI/ethernet), D-sub 25-pin digital I/O port (for internal/external trigger signals and handler control), and TSP-Link connectors make it simple to configure multiple instrument test solutions and eliminate the need to invest in additional adapter accessories.

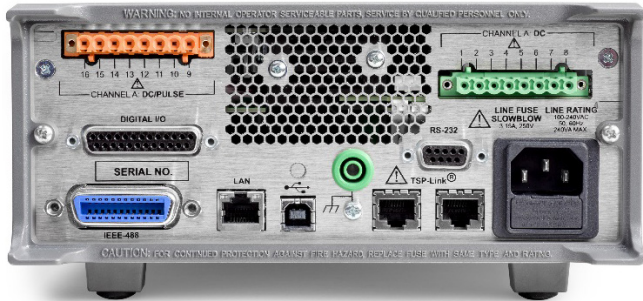

2601B-PULSE rear panel.

The 2601B-P-INT interlock / connector box interconnects both the SMU and Pulser functions and converts both of the Phoenix connectors on the rear panel to standard BNC connectors. The interlock/connector box also provides an optional safety interlock for use when testing LASER devices.



2601B-PULSE Interlock / Connector (front/rear), included with 2601B-PULSE

Typical Applications

I-V functional test and characterization of a wide range of devices, including:

- Optoelectronic devices such as vertical cavity surface-emitting lasers (VCSELs), laser diodes, light emitting diodes (LEDs), high brightness LEDs (HBLEDs), displays
- Discrete and passive components including sensors, disk drive heads, metal oxide varistors (MOVs), diodes, Zener diodes, sensors, capacitors, thermistors
- Simple ICs – Optos, drivers, switches, sensors, converters, regulators
- Integrated devices – small scale integrated (SSI) and large scale integrated (LSI)
 - Analog ICs
 - Radio frequency integrated circuits (RFICs)
 - Application specific integrated circuits (ASICs)
 - System on a chip (SOC) devices
- Wafer level reliability
 - NBTI, TDDDB, HCI, electromigration
- Batteries
- Failure Analysis
- And more...

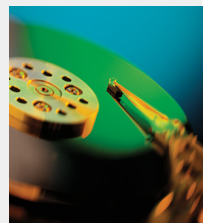
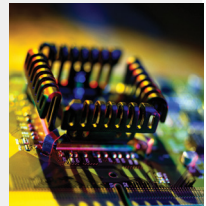
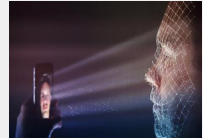
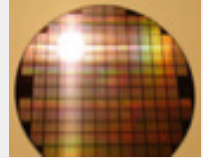

Specifications

Specification Conditions

This document contains specifications and supplemental information for the 2601B-PULSE System SourceMeter 10 μ s Pulser/SMU Instrument. Specifications are the standards against which the 2601B-PULSE is tested. Upon leaving the factory, the 2601B-PULSE meets these specifications. Supplemental and typical values are non-warranted, apply at 23 °C, and are provided solely as useful information.

Accuracy specifications are applicable for both normal and High Capacitance modes.

The source and measurement accuracies are specified at the terminals of the Pulser/SMU instrument under the following conditions:

1. 18 °C to 28 °C, <70% relative humidity
2. After 2 hour warm-up
3. Speed normal (1 NPLC)
4. A/D auto-zero enabled
5. Remote sense operation only or properly zeroed local operation
6. Calibration period = 1 year

Pulser feature specification accuracies are specified at the terminals of the instrument under these conditions:

- 10 μ s aperture minimum.
- Remote sense operation only.
- Total cable and DUT inductance of $\leq 3 \mu$ H, measured at 100 kHz

Pulser Feature Specifications

Pulser Source Specifications ^{1, 2}

Current Pulse Termination

The current pulse will terminate within 3 μ s after terminal voltages exceed a bipolar, programmable abort threshold. Separate abort thresholds can be programmed for the sense terminals and the source terminals.

The sense threshold can be set from 5% to 200% of the selected Measure Voltage range.

The source threshold can be set from 2 V to 40 V, independent of range. The source threshold ignores normal transients during pulse rise and fall time.

Programmable threshold uncertainty is $\pm 5 \%$.

Pulser Current Source Specifications

Current Programming Accuracy

Range	Programming Resolution	Accuracy (1 Year) \pm (% rdg. + amps)	Typical Noise (RMS) 10 kHz–1 MHz
1 A	100 μ A	0.17% + 2.0 mA	380 μ A
5 A	100 μ A	0.17% + 2.5 mA	1.4 mA
10 A	100 μ A	0.22% + 3.0 mA	3.1 mA ³

Temperature Coefficient (0°–18 °C and 28°–50 °C)

$\pm (0.15 \times \text{accuracy specification})/\text{°C}$.

Pulsing Limits ^{4, 5}

± 10 A @ ± 10 V pulse, 3% duty cycle
 ± 3 A @ ± 10 V pulse, 10% duty cycle
 ± 1.0 A @ ± 10 V pulse, 30% duty cycle
 ± 500 mA @ ± 10 V pulse, 60% duty cycle⁶
 ± 250 mA @ ± 10 V continuous

Current Regulation

Line: 0.01% of range. **Load:** $\pm 100 \mu$ A.

Overshoot

< $\pm 0.5\%$ of step size (typical).

NOTES

1. Full power source operation regardless of load to 28 °C ambient. Above 28 °C and/or power sink operation, refer to "Operating Boundaries" in the 2601B-PULSE Reference Manual for additional power derating information.
2. Source valid for steady state output values. See settling time specification defining the steady state output requirement.
3. For pulses longer than 100 μ s, there can be a thermal drift of up to 0.004% of source value. This drift is already included in the overall source accuracy specifications.
4. Thermally limited in sink mode (quadrants 2 and 4) and ambient temperatures above 28 °C. See pulse power quadrant diagram for more information.
5. Duty cycles listed can only be achieved if bias current is ≤ 10 mA.
6. Due to Pulse Width Programming, Minimum t_{off} .

Additional Pulser Source Specifications

Rise Time (10% to 90%) <1.7 μ s for a full-scale step of current into any load voltage (10 V maximum).

Additional Zero-Crossing Delay $1 \mu\text{s} + \frac{200 \text{ (ns} \times \text{A)}}{\text{Pulse Current (in Amps)}}$

Pulse Current and Duty Cycle Maximum duty cycle is given by:

$$\frac{0.3125 - |I_{bias}|}{|I_{pulse}| - |I_{bias}|} * 100\%$$

For $I_{bias} \leq 10 \text{ mA}$:

Pulse Current	Max. Duty Cycle
$\pm 10 \text{ A}$	3 %
$\pm 5 \text{ A}$	6 %
$\pm 3 \text{ A}$	10 %
$\pm 1 \text{ A}$	30 %
$\pm 500 \text{ mA}$	60 %
$\pm 250 \text{ mA}$	100 %
0 A	

Current Source Output Settling Time

Time required to reach specified accuracy after the start of the pulse.

Current Range	Settling Time
1 A	< 9 μ s ($V_{load} \leq 10 \text{ V}$)
5 A	< 9 μ s ($V_{load} \leq 10 \text{ V}$)
10 A	< 9 μ s ($V_{load} \leq 10 \text{ V}$)

Output Off Normal State Electrical short (< 1 Ω) between HI and LO.
Maximum DC current from external sources during OUTPUT OFF state must be limited to <1 A.

Remote Voltage Sense Maximum voltage between HI and SENSE HI = $\pm 30 \text{ V}$.
Maximum voltage between LO and SENSE LO = $\pm 30 \text{ V}$.

Over Temperature Protection Internally sensed temperature overload puts unit in standby mode.

Safety Interlock Hardware interlock (available, optional).

Bias Current Source Specifications

Current Programming Accuracy

Range	Programming Resolution	Accuracy (1 Year) ±(% rdg. + amps)	Typical Noise (RMS) 0.1 Hz–100 kHz
250 mA	10 µA	0.17% + 1 mA	200 µA

Temperature Coefficient (0°–18 °C and 28°–50 °C)
± (0.15 × accuracy specification)/°C.

Pulse Width Programming Resolution	1 µs.
Pulse Width Programming Maximum	500 µs.
Pulse Width Programming Minimum	10 µs.
Pulse Width Programming Accuracy	±200 ns.
Pulse Width Jitter	110 ns (typical).
Pulse Period Jitter	2 µs (typical).
Pulse Width Programming, Minimum t _{off}	16 µs.

Pulser Feature Measure Specifications

Voltage Measurement Specifications

Voltage Measurement Accuracy

Range	Display Resolution	Accuracy (1 Year) 23 °C ± 5 °C ± (% rdg. + volts) ¹
5 V	1 µV	0.05% + 2.5 mV
10 V	10 µV	0.05% + 4 mV

Voltage Measurement Settling Time Time required to reach specified accuracy after a source level command is processed on a fixed range.

Voltage Range	Settling Time (typical)
5 V and 10 V	< 9 µs

Temperature Coefficient (0°–18 °C and 28°–50 °C)
± (0.15 × accuracy specification)/C.

Current Measurement Specifications

Current Measurement Accuracy

Range	Display Resolution	Accuracy (1 Year) 23 °C \pm 5 °C \pm (% rdg. + amps) ¹
1 A	1 μ A	0.12% + 0.5 mA
5 A	1 μ A	0.12% + 1 mA
10 A	10 μ A	0.12% + 1 mA

Current Measure Settling Time Time required to reach specified accuracy of after source level command is processed on a fixed range.
Current Range: 1 A – 10 A.
Settling Time: < 9 μ s (typical).

Temperature Coefficient (0°–18 °C and 28°–50 °C)
 \pm (0.15 \times accuracy specification)/°C.

Additional Pulser Characteristics

Maximum Load Inductance 3 μ H (cable plus device under test (DUT)), measured at 100 kHz.

Common Mode Isolation >1 G Ω , <4500 pF.

Overrange 100% of bias range, 101% of source range, 102% of measure range.

Maximum Source/Sense Lead Resistance 0.5 Ω / 100 Ω per lead.

Sense High/Low Input Impedance 2 M Ω (typical).

SMU-to-Pulser Transition Time <7 ms.

A/D Aperture Characteristics

A/D Converter Speed		1 μ s	10 μ s	100 μ s
Effective Number of Conversions		1	10	100
Effective Number of Bits (ENOB)	Current	12	14	15
	Voltage	14	16	18
Additional Measure Current Noise Uncertainty		\pm 1.5 mA	0 A	0 A
Additional Measure Voltage Noise Uncertainty		\pm 0.03% of measure voltage range	0%	0%

NOTES

1. Accuracies valid for 10 μ s aperture, measurement beginning at the end of the settling time. Refer to A/D Aperture Characteristics for other apertures.

SMU Specifications

Voltage Source Specifications

Voltage Accuracy¹

Range	Programming Resolution	Accuracy (1 Year) ±(% rdg. + volts)	Typical Noise (peak-peak) 0.1 Hz–10 Hz
100 mV	5 µV	0.02% + 250 µV	20 µV
1 V	50 µV	0.02% + 400 µV	50 µV
6 V	50 µV	0.02% + 1.8 mV	100 µV
40 V	500 µV	0.02% + 12 mV	500 µV

Temperature Coefficient (0°–18 °C and 28°–50 °C)²

±(0.15 × accuracy specification)/ °C. Applicable for normal mode only. Not applicable for High Capacitance Mode.

Maximum Output Power and Source/Sink Limits³

40.4 W maximum. ±40.4 V @ ±1.0 A, ±6.06 V @ ±3.0 A, four quadrant source or sink operation.

NOTES

1. Add 50 µV to source accuracy specifications per volt of HI lead drop.
2. High Capacitance Mode accuracy is applicable at 23 °C ±5 °C only.
3. Full power source operation regardless of load to 28 °C ambient. Above 28 °C and/or power sink operation, refer to "Operating Boundaries" in the 2601B-PULSE Reference Manual for additional power derating information.

Current Source Specifications

Current Accuracy

Range	Programming Resolution	Accuracy (1 Year) ±(% rdg. + amps)	Typical Noise (peak-peak) 0.1Hz–10Hz
100 nA	2 pA	0.1% + 100 pA	5 pA
1 µA	20 pA	0.03% + 800 pA	25 pA
10 µA	200 pA	0.03% + 5 nA	60 pA
100 µA	2 nA	0.03% + 60 nA	3 nA
1 mA	20 nA	0.03% + 300 nA	6 nA
10 mA	200 nA	0.03% + 6 µA	200 nA
100 mA	2 µA	0.03% + 30 µA	600 nA
1 A	20 µA	0.05% + 1.8 mA	70 µA
3 A	20 µA	0.06% + 4 mA	150 µA
10 A ²	200 µA	0.5% + 40 mA	N/A

Temperature Coefficient (0°–18 °C and 28°–50 °C)³

±(0.15 × accuracy specification)/ °C.

Maximum Output Power and Source/Sink Limits¹

40.4 W maximum. ±1.01 A @ ±40.0 V, ±3.03 A @ ±6.0 V, four quadrant source or sink operation.

NOTES

1. Full power source operation regardless of load to 28 °C ambient. Above 28 °C and/or power sink operation, refer to "Operating Boundaries" in the 2601B-PULSE Reference Manual for additional power derating information.
2. 10 A Range is accessible in SMU extended range mode only. Accuracy specifications for 10 A range are typical.
3. High Capacitance Mode accuracy is applicable at 23 °C ±5 °C only.

Additional Source Characteristics

Noise, 10 Hz to 20 MHz <20 mV peak-peak, < 3 mVRMS.
6 V range.

Transient Response Time < 70 μ s for the output to recover to within 0.1% for a 10% to 90% step change in load.

Overshoot

Voltage < \pm 0.1% + 10 mV. Step size = 10% to 90% of range, resistive load, maximum current limit/compliance.

Current < \pm 0.1%. Step size = 10% to 90% of range, resistive load.
See Current Source output settling time for additional test conditions.

Range Change Overshoot

Voltage¹ <300 mV + 0.1% of larger range. Overshoot into a 100 k Ω load, 20 MHz bandwidth.

Current² <300 mV/R_{LOAD} + 5% of larger range.

Guard Offset Voltage < 4 mV. Current <10 mA.

Remote Sense Operating Range³ Maximum voltage between HI and SENSE HI = 3 V.
Maximum voltage between LO and SENSE LO = 3 V.

Voltage Output Headroom

40 V Range Maximum output voltage = 42 V – (total voltage drop across source leads). Maximum 1 Ω per source lead.

6 V Range Maximum output voltage = 8 V – (total voltage drop across source leads). Maximum 1 Ω per source lead.

Overtemperature Protection Internally sensed overtemperature condition puts the instrument in standby mode.

Limit/Compliance Bipolar limit (compliance) set with a single value.

Voltage⁴ Minimum value is 10 mV; accuracy is the same as voltage source.

Current⁵ Minimum value is 10 nA; accuracy is the same as current source.

Voltage Source Output Settling Time

Time required to reach within 0.1% of final value after source level command is processed on a fixed range.

Voltage Range	Settling Time
100 mV	< 50 μ s
1 V	< 50 μ s
6 V	< 110 μ s
40 V ⁶	< 150 μ s

Current Source Output Settling Time

Time required to reach within 0.1% of final value after source level command is processed on a fixed range.
Values below for I_{OUT} × R_{LOAD} = 1 V unless noted.

Current Range	Settling Time
100 nA	< 20 ms
1 μ A	< 2 ms
10 μ A	< 500 μ s
100 μ A	< 150 μ s
1 mA	< 100 μ s
10 mA to 1 A	< 80 μ s (R _{LOAD} > 6 Ω)
3 A	< 80 μ s (Current < 2.5 A, R _{LOAD} > 2 Ω)

NOTES

- Add 200 mV for the 6 V to 40 V change.
- With source settling set to SETTLE_SMOOTH_100NA.
- Add 50 μ V to source accuracy specifications per volt of HI lead drop.
- For sink operation (quadrants II and IV) without sink mode enabled, add 10% of compliance range and \pm 0.02% of limit settling to the corresponding voltage source accuracy specifications. For the 100 mV range, add an additional 60 mV of uncertainty. Specifications apply with sink mode enabled.
- For sink operation (quadrants II and IV) without sink mode enabled, add 0.06% of limit range to the corresponding current limit accuracy specifications. Specifications apply with sink mode enabled.
- Add 150 μ s when measuring on the 1 A range.

Meter Specifications

Voltage Measurement Accuracy¹

Range	Default Display Resolution	Accuracy (1 Year) ² , ±(% rdg. + volts)
100 mV	100 nV	0.015% + 150 μV
1 V	1 μV	0.015% + 200 μV
6 V	10 μV	0.015% + 1 mV
40 V	10 μV	0.015% + 8 mV

Temperature Coefficient (0°–18 °C and 28°–50 °C)³
±(0.15 × accuracy specification)/ °C.

Current Measurement Accuracy

Range	Default Display Resolution	Accuracy (1 Year) ² , ±(% rdg. + amps)
100 nA	100 fA	0.08% + 100 pA
1 μA	1 pA	0.025% + 500 pA
10 μA	10 pA	0.025% + 1.5 nA
100 μA	100 pA	0.02% + 25 nA
1 mA	1 nA	0.02% + 200 nA
10 mA	10 nA	0.02% + 2.5 μA
100 mA	100 nA	0.02% + 20 μA
1 A	1 μA	0.03% + 1.5 mA
3 A	1 μA	0.05% + 3.5 mA
10 A ⁴	10 μA	0.4% + 25 mA

Temperature Coefficient (0°–18 °C and 28°–50 °C)³
±(0.15 × accuracy specification)/ °C. Applicable for normal mode only. Not applicable for High Capacitance Mode.

NOTES

1. Add 50 μV to source accuracy specifications per volt of HI lead drop.
2. De-rate accuracy specifications for NPLC setting <1 by increasing error term. Add appropriate typical percent of reading term for resistive loads using the table below.

NPLC Setting	100 mV Range	1 V–40 V Ranges	100 nA Range	1 μA–100 mA Ranges	1 A–3 A Ranges
0.1	0.01%	0.01%	0.01%	0.01%	0.01%
0.01	0.08%	0.07%	0.1%	0.05%	0.05%
0.001	0.8 %	0.6 %	1%	0.5 %	1.1 %

3. High Capacitance Mode accuracy is applicable for 23 °C ±5 °C only.
4. 10 A Range is accessible in SMU extended range mode only. Accuracy specifications for 10 A range are typical.

Additional Measurement Characteristics

Contact Check Specifications¹

Speed	Maximum Measurement Time to Memory for 60 Hz (50 Hz)	Accuracy (1 year) ±(% reading + ohms)
Fast	1 ms (1 ms)	5% + 10 Ω
Medium	4 ms (5 ms)	5% + 1 Ω
Slow	35 ms (42 ms)	5% + 0.3 Ω

Current Measure Settling Time² Time required to reach within 0.1% of final value after source level command is processed on a fixed range. Values below for $V_{OUT} = 1 V$.

Current Range	Settling Time
1 mA	< 100 μs

Input Impedance > 10 GΩ.

NOTES

1. Includes measurement of SENSE HI to HI and SENSE LO to LO contact resistances.
2. Compliance equal to 100 mA.

Additional Characteristics

Maximum Load Impedance

Normal Mode 10 nF.

High Capacitance Mode 50 μ F.

Overrange 101% of source range, 102% of measure range.

Maximum Sense Lead Resistance 1 k Ω for rated accuracy.

Sense High Input Impedance >10 G Ω .

High Capacitance Mode ^{1, 2, 3}

Accuracy Specifications Accuracy specifications are applicable in both Normal and High Capacitance Modes.

Voltage Source Output Settling Time Time required to reach 0.1% of final value after source level command is processed on a fixed range. Current limit = 1 A.

Voltage Source Range	Settling Time with $C_{load} = 4.7 \mu F$
100 mV	<200 μ s
1 V	<200 μ s
6 V	<200 μ s
40 V	<7 ms

Current Measure Settling Time Time required to reach 0.1% of final value after voltage source is stabilized on a fixed range. Values below for $V_{out} = 1V$ unless noted.

Current Range	Settling Time
1 μ A	< 230 ms
10 μ A	< 230 ms
100 μ A	< 3 ms
1 mA	< 3 ms
10 mA – 100 mA	<100 μ s
1 A – 3 A	<120 μ s ($R_{load} > 2 \Omega$)

Capacitor Leakage Performance Using the KIHighC Factory Script ⁴

Load = 5 μ F||10 M Ω . Test: 5 V step and measure. 200 ms (typical) @ 50 nA.

NOTES

- High Capacitance Mode specifications are for DC measurements only.
- 100 nA range is not available in High Capacitance Mode.
- High Capacitance Mode uses locked ranges. Auto Range is disabled.
- Part of KI Factory scripts. See reference manual for details.

Mode Change Delay

Current Ranges of 100 μ A and Above Delay into High Capacitance Mode: 11 ms.
Delay out of High Capacitance Mode: 11 ms.

Current Ranges Below 100 μ A Delay into High Capacitance Mode: 250 ms.
Delay out of High Capacitance Mode: 11 ms.

Voltmeter Input Impedance 10 G Ω in parallel with 3300 pF.

Noise, 10 Hz–20 MHz (6 V Range) <30 mV peak-peak (typical).

Voltage Source Range Change Overshoot

<400 mV + 0.1% of larger range. Overshoot into a 100 k Ω load, 20 MHz bandwidth.

SMU Pulse Characteristics

Region	Maximum Current Limit	Maximum Pulse Width ¹	Maximum Duty Cycle ²
1	1 A @ 40 V	DC, no limit	100%
1	3 A @ 6 V	DC, no limit	100%
2	1.5 A @ 40 V	100 ms	25%
3	5 A @ 35 V	4 ms	4%
4	10 A @ 20 V	1.8 ms	1%
5	5 A @ 6 V	10 ms	10%

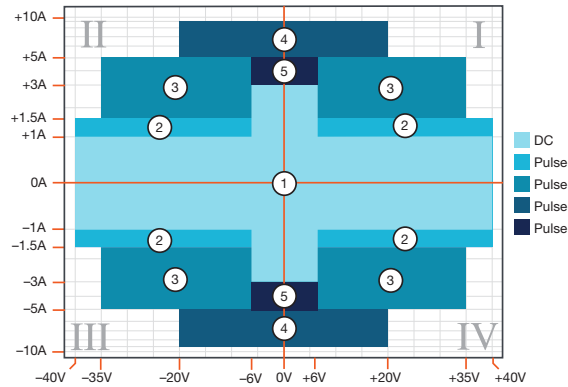

Minimum Programmable Width ^{1,3}	100 μ s. Note: Minimum pulse width for settled source at a given I/V output and load can be longer Pulse than 100 μ s.
Pulse Width Programming Resolution	1 μ s.
Pulse Width Programming Accuracy	± 5 μ s.
Pulse Width Jitter	2 μ s.

NOTES

- Times measured from the start of pulse to the start off-time; see figure below.

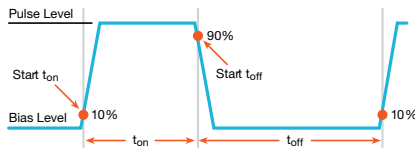

- Thermally limited in sink mode (quadrants II and IV) and ambient temperatures above 28 °C. See power equations in the reference manual for more information.
- Typical performance for minimum settled pulse widths:

Source Value	Load	Source Settling (% of range)	Min. Pulse Width
6 V	2 Ω	0.2%	150 μ s
20 V	2 Ω	1%	200 μ s
35 V	7 Ω	0.5%	500 μ s
40 V	27 Ω	0.1%	400 μ s
1.5 A	27 Ω	0.1%	1.5 ms
3 A	2 Ω	0.2%	150 μ s
5 A	7 Ω	0.5%	500 μ s
10 A	2 Ω	0.5%	200 μ s

SMU Measurement Speed Characteristics¹

Maximum Sweep Operation Rates (operations per second) for 60 Hz (50 Hz)

A/D Converter Speed (NPLC)	Trigger Origin	Measure To Memory Using User Scripts	Measure To USB Using User Scripts	Source Measure To Memory Using User Scripts	Source Measure To USB Using User Scripts	Source Measure To Memory Using Sweep API	Source Measure To USB Using Sweep API
0.001	Internal	20000 (20000)	9800 (9600)	6700 (6700)	6600 (6600)	13400 (13400)	6450 (6450)
0.001	Digital I/O	7400 (7400)	7250 (7250)	5500 (5500)	5400 (5400)	13400 (13400)	6500 (6500)
0.01	Internal	5000 (4300)	3900 (3400)	3300 (3000)	3300 (2900)	4400 (3800)	4400 (3800)
0.01	Digital I/O	3400 (3100)	3400 (3000)	2900 (2700)	2900 (2600)	4400 (3800)	4400 (3800)
0.1	Internal	580 (480)	560 (470)	550 (465)	550 (460)	570 (480)	570 (480)
0.1	Digital I/O	550 (460)	550 (460)	520 (450)	540 (450)	570 (480)	570 (480)
1.0	Internal	59 (49)	59 (49)	59 (49)	59 (49)	59 (49)	59 (49)
1.0	Digital I/O	59 (48)	59 (49)	59 (49)	59 (49)	59 (49)	59 (49)

Maximum Single Measurement Rates (operations per second) for 60 Hz (50 Hz)

A/D Converter Speed (NPLC)	Trigger Origin	Measure To USB	Source Measure To USB	Source Measure Pass/Fail To USB
0.001	Internal	2100 (2100)	1600 (1600)	1600 (1600)
0.01	Internal	1650 (1600)	1400 (1200)	1300 (1150)
0.1	Internal	480 (410)	450 (390)	400 (380)
1.0	Internal	58 (48)	57 (48)	57 (48)

Maximum Measurement Range Change Rate

>7000 per second for >10 μ A. When changing to or from a range \geq 1 A, maximum rate is >2200/second.

Maximum Source Range Change Rate

>400 per second >10 μ A. When changing to or from a range \geq 1 A, maximum rate is >190/second.

Maximum Source Function Change Rate

>1000 per second.

Command Processing Time

Maximum time required for the output to begin to change following the receipt of the `smua.source.levelv` or `smua.source.leveli` attribute. <1 ms.

NOTES

1. Exclude current measurement ranges less than 1 mA.

Triggering and Synchronization Characteristics

Triggering

Trigger in to Trigger Out 0.5 μ s, typical.

Trigger in to Source Change¹ 10 μ s, typical.

Trigger Timer Accuracy \pm 2 μ s, typical.

Source Change¹ After LXI Trigger
280 μ s, typical.

Synchronization

Single-Node Synchronized Source Change¹: <0.5 μ s, typical.

Multi-Node Synchronized Source Change¹: <0.5 μ s, typical.

NOTES

1. Fixed source range, with no polarity change.

General

IEEE-488	IEEE-488.1 compliant. Supports IEEE Std 488.2 common commands and status model topology.
USB Control (rear)	USB 2.0 device, USB-TMC488 protocol.
RS-232	Baud rates from 300 bps to 115200 bps.
Ethernet	RJ-45 connector, 10/100BaseT, Auto-MDIX.
Expansion Interface	<p>The TSP-Link expansion interface allows TSP-enabled instruments to trigger and communicate with each other.</p> <p>Cable Type: Category 5e or higher LAN crossover cable. 3 meters (9.84 ft) maximum between each TSP-enabled instrument.</p> <p>A maximum of 32 TSP-Link nodes can be interconnected. Each source-measure instrument uses one TSP-Link node.</p>

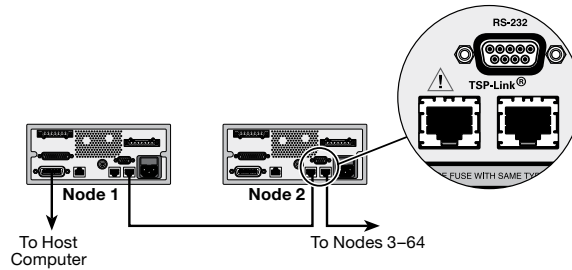

LXI Compliance	Version 1.5 LXI Device Specification 2016 compliant.
LXI Timing	<p>Total Output Trigger Response Time: 245 μs minimum, 280 μs typical, (not specified) maximum.</p> <p>Receive LAN[0-7] Event Delay: Unknown.</p> <p>Generate LAN[0-7] Event Delay: Unknown.</p>

Digital I/O Interface

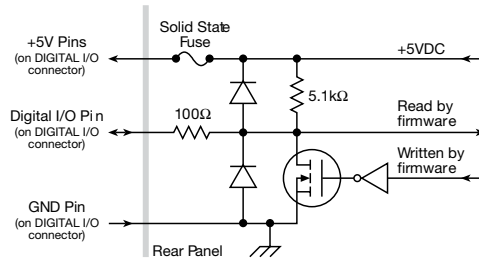

Connector	25-pin female D.
Input/Output Pins	14 open drain I/O bits.
Absolute Maximum Input Voltage	5.25 V.
Absolute Minimum Input Voltage	-0.25 V.
Maximum Logic Low Input Voltage	0.7 V, +850 μ A max.
Minimum Logic High Input Voltage	2.1 V, +570 μ A.
Maximum Source Current (flowing out of Digital I/O bit)	+960 μ A.
Maximum Sink Current @ Maximum Logic Low Voltage (0.7V)	-5.0 mA.
Absolute Maximum Sink Current (flowing into Digital I/O pin)	-11 mA.
5V Power Supply Pins	Limited to 250 mA total for all three pins, solid-state fuse protected.

USB File System (Front)	USB 2.0 Host: Mass storage class device.
Power Supply	100 V to 240 VAC, 50–60 Hz (auto sensing), 240 VA maximum.
Cooling	Forced air. Side intake and rear exhaust. One side must be unobstructed when rack mounted.
EMC	Conforms to European Union EMC Directive.
Safety	NRTL listed to UL61010-1:2008 and CSA C22.2 No. 61010-1. Conforms to European Union Low Voltage Directive.
Dimensions	
2601B-PULSE only	105 mm \times 235 mm \times 445 mm (4.1 in. high \times 9.25 in. wide \times 17.5 in. deep).
2601B-PULSE with 2601B-P-INT attached	105 mm \times 235 mm \times 503 mm (4.1 in. high \times 9.25 in. wide \times 19.82 in. deep).
Weight	2601B-PULSE only: 5.9 kg (13 lb). 2601B-PULSE with 2601B-P-INT attached: 6.4 kg (14 lb).
Environment	
Altitude	For indoor use only.
Operating	Maximum 2000 meters above sea level.
Storage	0 °C to 35 °C at up to 70% relative humidity; at 35 °C to 50 °C, derate 3% relative humidity per °C. –25 °C to 65 °C.

Supplemental Information

Front Panel Interface	Two-line vacuum fluorescent display (VFD) with keypad and rotary knob.
Display	Show error messages and user defined messages. Display source and limit settings. Show current and voltage measurements. View measurements stored in dedicated reading buffers.
Keypad Operations	Change host interface settings. Save and restore instrument setups. Load and run factory and user defined test scripts (i.e. sequences) that prompt for input and send results to the display. Store measurements into dedicated reading buffers.
Programming	Embedded Test Script Processor (TSP [®]) accessible from any host interface; responds to high-speed test scripts comprised of remote commands and statements (for example, branching, looping, and math); able to execute test scripts stored in memory without host intervention.
Minimum Memory Available	16 MB (approximately 250,000 lines of TSP code).
Reading Buffers	Nonvolatile memory uses dedicated storage areas reserved for measurement data. Reading buffers are arrays of measurement elements. Each element can store the following items: Measurement Source setting (at the time the measurement was made) Measurement status Range information Timestamp Reading buffers can be filled using the front panel STORE key and retrieved using the RECALL key or host interface. Buffer Size, with timestamp and source setting: >60,000 samples. Buffer Size, without timestamp and source setting: >140,000 samples.
Timer	Free running 47-bit counter with 1 MHz clock input. Reset each time instrument powers up. If the instrument is not turned off, the timer is automatically reset to zero (0) every four years.
Timestamp	TIMER value automatically saved when each measurement is triggered.
Resolution	1 μ s.
Accuracy	\pm 100 ppm.

Ordering Information

2601B-PULSE

2601B-PULSE System SourceMeter 10 μ s Pulser/SMU Instrument

Supplied Accessories

Operators and Programming Manuals

Available at www.tek.com/keithley

2601B-P-INT

2601B-PULSE Rear Panel Interlock and Cable Connector Box

7709-308A

Digital I/O Connector

17469460X

TSP-Link/Ethernet Cable (two per unit)

CS-1616-3

Safety Interlock Mating Connector

2601B-PULSE

QuickStart Guide

Available Accessories

Software

KickStart

Instrument Control Software

LabVIEW and IVI Drivers

Available at www.tek.com/keithley

Test Script Builder Software

Available at www.tek.com/keithley

Rack Mount Kits

4299-1

Single Rack Mount Kit with front and rear support

4299-2

Dual Rack Mount Kit with front and rear support

Cables and Connectors

2600-BAN

Banana Test Leads/Adapter Cable for use with the Channel A: SMU Phoenix Connector ONLY

2600-KIT

Extra screw terminal connector, strain relief, and cover for the Channel A: SMU Phoenix Connector ONLY

2601B-P-INT

2601B-PULSE Rear Panel Interlock and Cable Connector Box

2601B-PULSE-CA1

2601B-PULSE 1.2 meter 50 ohm BNC to BNC Cable Kit

2601B-PULSE-CA2

2601B-PULSE (two per unit) independent 3.0 meter 50 ohm BNC to BNC coax cables used for SHI and SLO. Required accessory for the 2601B-PULSE-CA3 cable set.

2601B-PULSE-CA3

2601B-PULSE 3.0 meter 15 ohm BNC to BNC Cable Kit. The 2601B-PULSE-CA2 option is required with this accessory.

7709-308A

Digital I/O Connector

8606

High Performance Modular Probe Kit. For use with 2600-BAN.

CS-1616-3

Safety Interlock Mating Connector

GPIB Interfaces and Cables

7007-1

Double Shielded GPIB Cable, 1 m (3.3 ft.)

7007-2

Double Shielded GPIB Cable, 2 m (6.6 ft.)

KPCI-488LPA

IEEE-488 Interface/Controller for the PCI Bus

KUSB-488B

IEEE-488 USB-to-GPIB Interface Adapter

Digital I/O, Trigger Link, and TSP-Link

2600-TLINK	Digital I/O to TLINK Adapter Cable, 1 m
17469460X	TSP-Link/Ethernet Cable (two per unit)
CA-126-1A	Digital I/O and Trigger Cable, 1.5 m

Test Fixtures and Adapters

7078-TRX-GND	3-slot make triax to female BNC adapter (guard removed). Used with 8101-PIV and 8101-4TRX test fixtures.
8101-4TRX	4 Pin Transistor Fixture
8101-PIV	DC, Pulse I-V and C-V Component Test Fixture
CS-1252	SMA male to BNC female adapter. Used with 8101-PIV test fixture.

Available Services

Extended Warranties

26xxB-EW	1 Year Factory Warranty extended to 2 years
26xxB-3Y-EW	1 Year Factory Warranty extended to 3 years
26xxB-5Y-EW	1 Year Factory Warranty extended to 5 years

Calibration Contracts

C/26xxB-3Y-STD	3 Calibrations within 3 years
C/26xxB-5Y-STD	5 Calibrations within 5 years
C/26xxB-3Y-DATA	3 Calibrations within 3 years and includes calibration data before and after adjustment
C/26xxB-5Y-DATA	5 Calibrations within 5 years and includes calibration data before and after adjustment
C/26xxB-3Y-17025	3 ISO-17025 accredited calibrations within 3 years
C/26xxB-5Y-17025	5 ISO-17025 accredited calibrations within 5 years

Warranty Information

Warranty Summary	This section summarizes the warranties of the 2601B-PULSE. Any portion of the product that is not manufactured by Keithley is not covered by this warranty and Keithley will have no duty to enforce any other manufacturer's warranties.
Hardware Warranty	Keithley Instruments, LLC. warrants the Keithley manufactured portion of the hardware for a period of one year from defects in materials or workmanship; provided that such defect has not been caused by use of the Keithley hardware which is not in accordance with the hardware instructions. The warranty does not apply upon any modification of Keithley hardware made by the customer or operation of the hardware outside the environmental specifications.
Software Warranty	Keithley warrants for the Keithley produced portion of the software or firmware will conform in all material respects with the published specifications for a period of ninety (90) days; provided the software is used on the product for which it is intended in accordance with the software instructions. Keithley does not warrant that operation of the software will be uninterrupted or error-free, or that the software will be adequate for the customer's intended application. The warranty does not apply upon any modification of the software made by the customer.

Contact Information:

- Australia** 1 800 709 465
- Austria*** 00800 2255 4835
- Balkans, Israel, South Africa and other ISE Countries** +41 52 675 3777
- Belgium*** 00800 2255 4835
- Brazil** +55 (11) 3759 7627
- Canada** 1 800 833 9200
- Central East Europe / Baltics** +41 52 675 3777
- Central Europe / Greece** +41 52 675 3777
- Denmark** +45 80 88 1401
- Finland** +41 52 675 3777
- France*** 00800 2255 4835
- Germany*** 00800 2255 4835
- Hong Kong** 400 820 5835
- India** 000 800 650 1835
- Indonesia** 007 803 601 5249
- Italy** 00800 2255 4835
- Japan** 81 (3) 6714 3010
- Luxembourg** +41 52 675 3777
- Malaysia** 1 800 22 55835
- Mexico, Central/South America and Caribbean** 52 (55) 56 04 50 90
- Middle East, Asia, and North Africa** +41 52 675 3777
- The Netherlands*** 00800 2255 4835
- New Zealand** 0800 800 238
- Norway** 800 16098
- People's Republic of China** 400 820 5835
- Philippines** 1 800 1601 0077
- Poland** +41 52 675 3777
- Portugal** 80 08 12370
- Republic of Korea** +82 2 565 1455
- Russia / CIS** +7 (495) 6647564
- Singapore** 800 6011 473
- South Africa** +41 52 675 3777
- Spain*** 00800 2255 4835
- Sweden*** 00800 2255 4835
- Switzerland*** 00800 2255 4835
- Taiwan** 886 (2) 2656 6688
- Thailand** 1 800 011 931
- United Kingdom / Ireland*** 00800 2255 4835
- USA** 1 800 833 9200
- Vietnam** 12060128

* European toll-free number. If not accessible, call: +41 52 675 3777



Find more valuable resources at TEK.COM

